

## 1. General description:

Silicon Carbide Schottky diode in a TO220-2L plastic package, designed for high frequency switched-mode power supplies.



## 2. Features and benefits:

- Zero Reverse Recovery Current
- Positive temperature coefficient
- Temperature-independent performance
- High-speed switching
- Low switching loss
- Low heat dissipation requirements

## 3. Applications:

- Switching power supply
- Power factor correction
- Motor drive, traction
- Charging pile
- PC Silverbox

## 4. Typical Performance Diagrams and Package:

$V_{RRM}$	1200	V
$I_F(135^{\circ}C)$	17	A
$Q_C$	76.5	nC

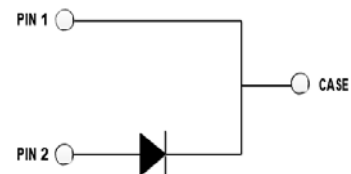

## 5. Ordering information:

Parts Number	Marking	Package	Vde min	IF max(A)	Pins	SPQ	Packaging
TSSiC120S015C	TSSiC120S015C	TO-220-2L	1200V	15A	2	600	Tube

## Table of Contents

---

1 Features .....	1
2 Applications .....	1
3 Description .....	1
4 Diagrams and Package .....	1
5 Ordering information .....	1
6 Table of Contents.....	2
6 Absolute Maximum Ratings .....	3
7 Thermal Characteristics.....	3
8 Electrical Characteristics .....	3
9 Typical Electrical Characteristics Curves.....	4
10 Package .....	5
11 Ordering information .....	6
12 Notes .....	6

## 6. Absolute Maximum Ratings

Parameter	Symbol	Value	Unit	Test Conditions
Reverse voltage (Repetitive peak)	$V_{RRM}$	1200	V	$T_C = 25^\circ\text{C}$
Reverse Voltage (Surge peak)	$V_{RSM}$	1200		$T_C = 25^\circ\text{C}$
Reverse voltage (DC)	$V_{DC}$	1200		$T_C = 25^\circ\text{C}$
Continuous forward current	$I_F$	36	A	$T_C = 25^\circ\text{C}$
		17		$T_C = 135^\circ\text{C}$
		15		$T_C = 144^\circ\text{C}$
Surge non-repetitive forward current	$I_{FSM}$	150	A	$T_C = 25^\circ\text{C}$ , $t_p = 10\text{ms}$ , half Sine Pulse
Total power dissipation	$P_{TOT}$	136	W	$T_C = 25^\circ\text{C}$
$i^2t$ value	$\int i^2 dt$	112	$\text{A}^2\text{s}$	$T_C = 25^\circ\text{C}$ , $t_p = 10\text{ms}$
Operating temperature	$T_j$	-55~175	$^\circ\text{C}$	
storage temperature	$T_{stg}$	-55~175	$^\circ\text{C}$	
Mounting Torque	M	1	Nm	M3 Screw

Note:  $I_F$  is theoretically calculated data.

## 7. Thermal Characteristics

Parameter	Symbol	Values			Unit	Test Condition
		Min.	Typ.	Max.		
Thermal resistance	$R_{th(j-c)}$	/	1.1	/	$^\circ\text{C/W}$	

## 8. Electrical Characteristics $T_j = 25^\circ\text{C}$

Parameter	Symbol	Values			Unit	Test Condition
		Min.	Typ.	Max.		
DC blocking voltage	$V_{DC}$	1200	/	/	V	$I_R = 100 \mu\text{A}$
Forward voltage	$V_F$	/	1.5	1.8	V	$I_F = 15\text{A}$ , $T_j = 25^\circ\text{C}$
		/	2.1	2.7		$I_F = 15\text{A}$ , $T_j = 175^\circ\text{C}$
Reverse current	$I_R$	/	5	40	$\mu\text{A}$	$V_R = 1200\text{V}$ , $T_j = 25^\circ\text{C}$
		/	40	250		$V_R = 1200\text{V}$ , $T_j = 175^\circ\text{C}$
Total capacitance	C	/	1059	/	pF	$V_R = 0\text{V}$ , $f = 1\text{MHz}$
		/	70.2	/		$V_R = 400\text{V}$ , $f = 1\text{MHz}$
		/	54.6	/		$V_R = 800\text{V}$ , $f = 1\text{MHz}$
Total capacitive charge	$Q_C$	/	76.5	/	nC	$V_R = 800\text{V}$
Capacitance Stored Energy	$E_C$	/	22	/	$\mu\text{J}$	$V_R = 800\text{V}$

## 9. Typical Electrical Characteristics Curves

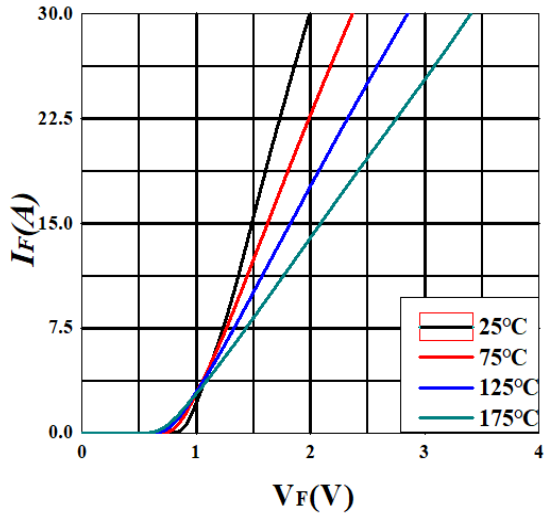

Figure 1. Forward Characteristics

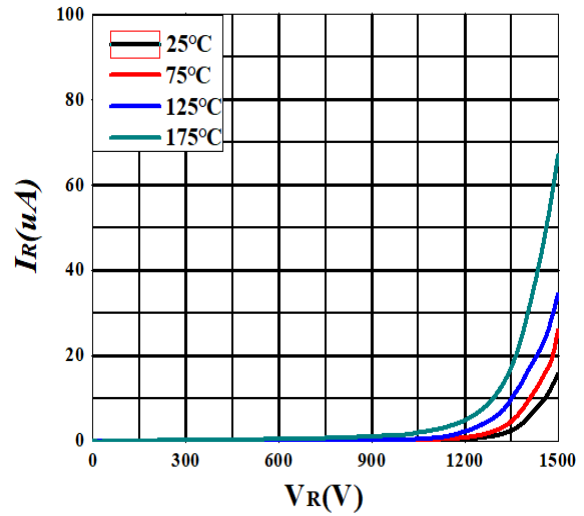

Figure 2. Reverse Characteristics

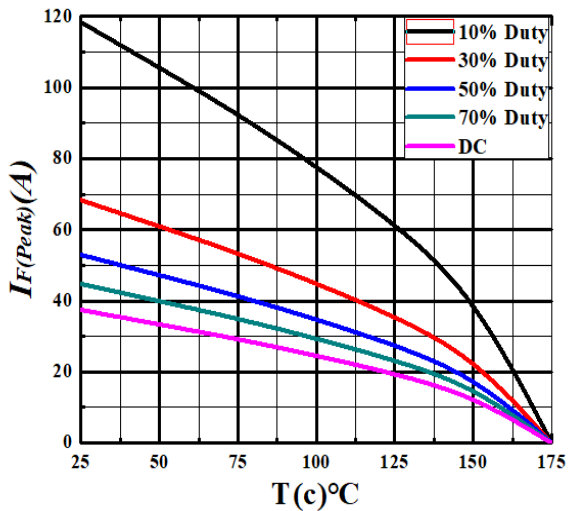

Figure 3. Current Derating

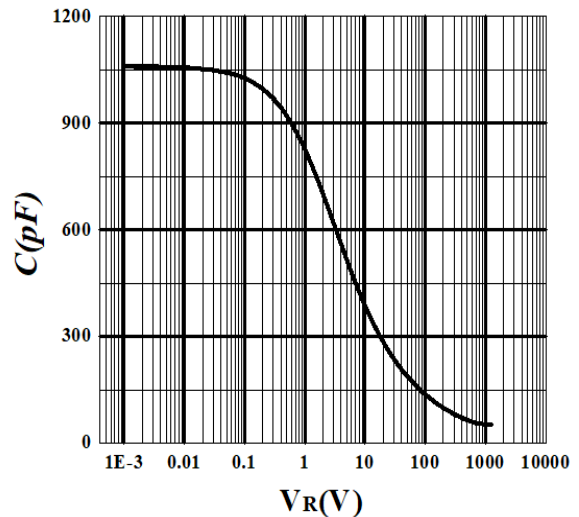

Figure 4. Capacitance vs. Reverse Voltage

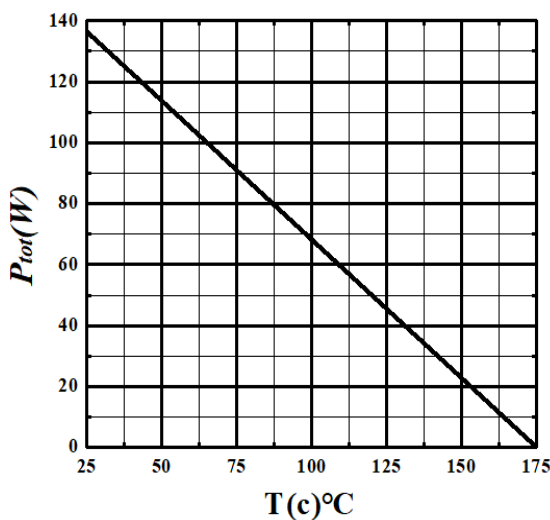

Figure 5. Power Derating

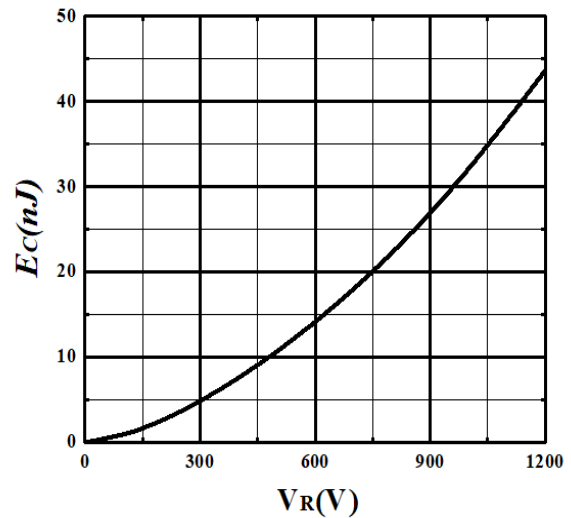

Figure 6. Capacitance Stored Energy

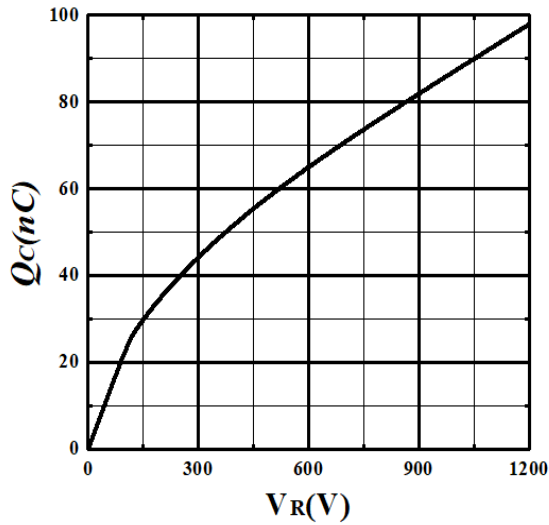
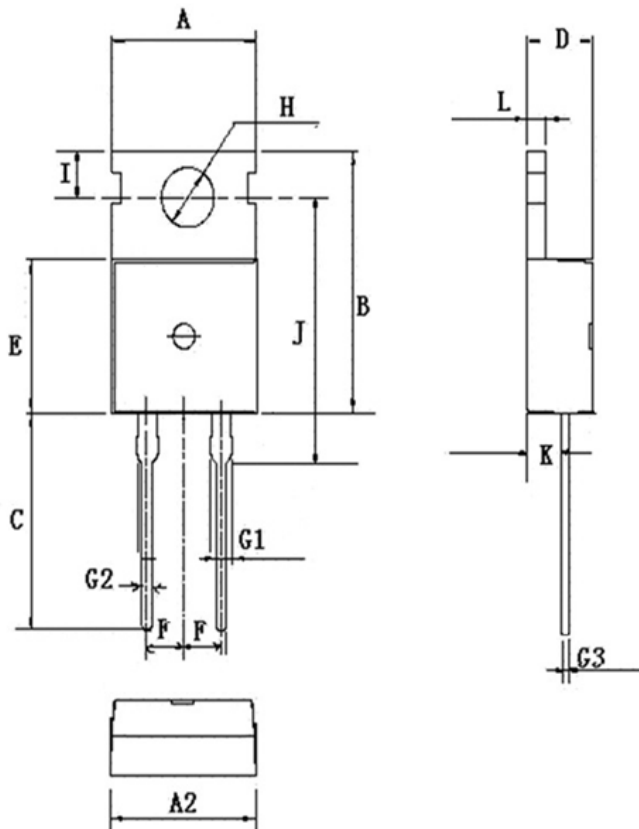

Figure 7. Total Capacitance Charge vs. Reverse Voltage

## 10. Package



SYMBOL	mm		
	MIN	NOM	MAX
A	9.66	9.90	10.28
A2	9.80	10.00	10.20
B	15.60	15.70	15.80
C	12.70	13.08	14.27
D	4.30	4.50	4.70
E	8.59	9.20	9.40
F	2.54 BSC		
G1	1.32	1.52	1.62
G2	0.70	0.80	0.95
G3	0.45	0.50	0.60
H dia.	3.50	3.60	3.70
I	2.70	2.80	2.90
J	15.70	15.90	16.25
K	2.20	2.40	2.90
L	1.15	1.30	1.40

## 11. Ordering information

---

Part Number	TSSiC120S015C
Package	TO-220-2L
Marking	TSSiC120S015C
Unit Quantity	600 EA
Packing Type	Tube
RoHS	Yes

## 12. Notes

---

SiC Schottky diode portfolio: <http://www.thrivesemi.com/>

Copyright © 2020 Thrivesemi Microelectronic Technology Co., Ltd. All Rights Reserved.