

1. General description:

Silicon Carbide Schottky diode in a TO-220-2L plastic package, designed for high frequency switched-mode power supplies.



2. Features and benefits:

- Zero Reverse Recovery Current
- Positive temperature coefficient
- Temperature-independent performance
- High-speed switching
- Low switching loss
- Low heat dissipation requirements

3. Applications:

- Switching power supply
- Power factor correction
- Motor drive, traction
- Charging pile
- PC Silverbox

4. Typical Performance Diagrams and Package:

V_{RRM}	650	V
$I_F(135^{\circ}C)$	27	A
Q_c	68.8	nC

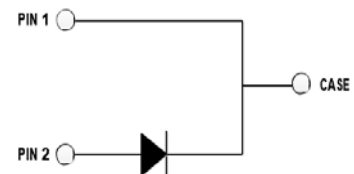

5. Ordering information:

Parts Number	Marking	Package	Vde min	IF max(A)	Pins	SPQ	Packaging
TSSiC065S020C	TSSiC065S020C	TO-220-2L	650V	20A	2	600	Tube

Table of Contents

1 Features	1
2 Applications	1
3 Description	1
4 Diagrams and Package	1
5 Ordering information	1
6 Table of Contents.....	2
6 Absolute Maximum Ratings	3
7 Thermal Characteristics.....	3
8 Electrical Characteristics	3
9 Typical Electrical Characteristics Curves.....	4
10 Package	5
11 Ordering information	6
12 Notes	6

6. Absolute Maximum Ratings

Parameter	Symbol	Value	Unit	Test Conditions
Reverse voltage (Repetitive peak)	V_{RRM}	650	V	$T_C = 25^\circ\text{C}$
Reverse Voltage (Surge peak)	V_{RSM}	650		$T_C = 25^\circ\text{C}$
Reverse voltage (DC)	V_{DC}	650		$T_C = 25^\circ\text{C}$
Continuous forward current	I_F	54	A	$T_C = 25^\circ\text{C}$
		27		$T_C = 135^\circ\text{C}$
		20		$T_C = 152^\circ\text{C}$
Surge non-repetitive forward current	I_{FSM}	180	A	$T_C = 25^\circ\text{C}$, $t_P = 10\text{ms}$, half Sine Pulse
Total power dissipation	P_{TOT}	208	W	$T_C = 25^\circ\text{C}$
i^2t value	$\int i^2 dt$	162	A^2s	$T_C = 25^\circ\text{C}$, $t_P = 10\text{ms}$
Operating temperature	T_j	-55~175	$^\circ\text{C}$	
storage temperature	T_{stg}	-55~175	$^\circ\text{C}$	
Mounting Torque	M	1	Nm	M3 Screw

Note: I_F is theoretically calculated data.

7. Thermal Characteristics

Parameter	Symbol	Values			Unit	Test Condition
		Min.	Typ.	Max.		
Thermal resistance	$R_{th(j-c)}$	/	0.72	/	$^\circ\text{C/W}$	

8. Electrical Characteristics $T_j = 25^\circ\text{C}$

Parameter	Symbol	Values			Unit	Test Condition
		Min.	Typ.	Max.		
DC blocking voltage	V_{DC}	650	/	/	V	$I_R = 100 \mu\text{A}$
Forward voltage	V_F	/	1.4	1.7	V	$I_F = 10\text{A}$, $T_j = 25^\circ\text{C}$
		/	1.6	2.5		$I_F = 10\text{A}$, $T_j = 175^\circ\text{C}$
Reverse current	I_R	/	10	50	μA	$V_R = 650\text{V}$, $T_j = 25^\circ\text{C}$
		/	50	300		$V_R = 650\text{V}$, $T_j = 175^\circ\text{C}$
Total capacitance	C	/	1392	/	pF	$V_R = 0\text{V}$, $f = 1\text{MHz}$
		/	129	/		$V_R = 200\text{V}$, $f = 1\text{MHz}$
		/	109	/		$V_R = 400\text{V}$, $f = 1\text{MHz}$
Total capacitive charge	Q_C	/	68.8	/	nC	$V_R = 400\text{V}$
Capacitance Stored Energy	E_C	/	10.3	/	μJ	$V_R = 400\text{V}$

9. Typical Electrical Characteristics Curves

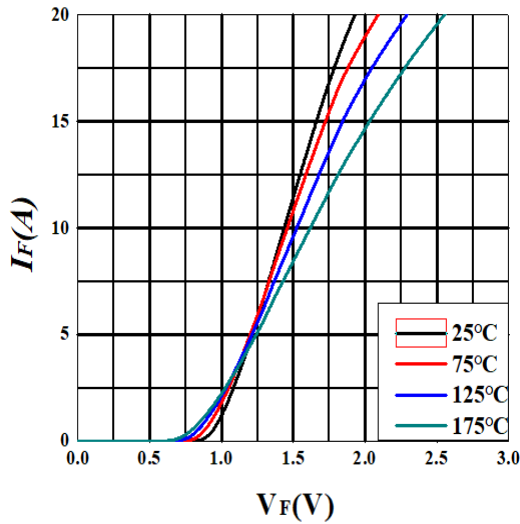

Figure 1. Forward Characteristics

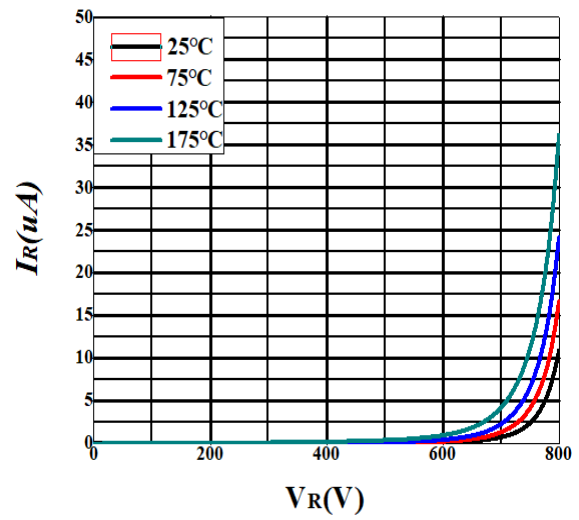

Figure 2. Reverse Characteristics

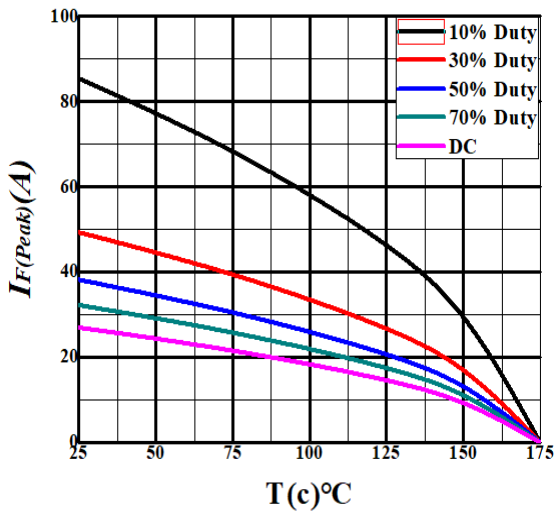

Figure 3. Current Derating

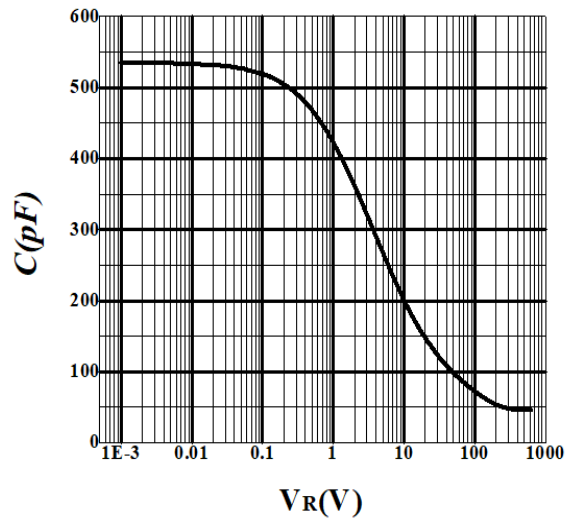

Figure 4. Capacitance vs. Reverse Voltage

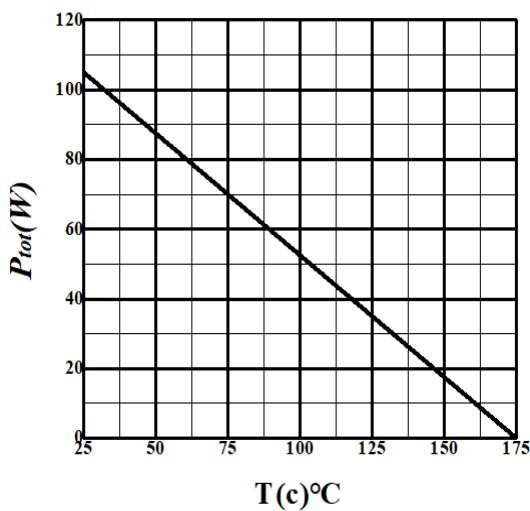

Figure 5. Power Derating

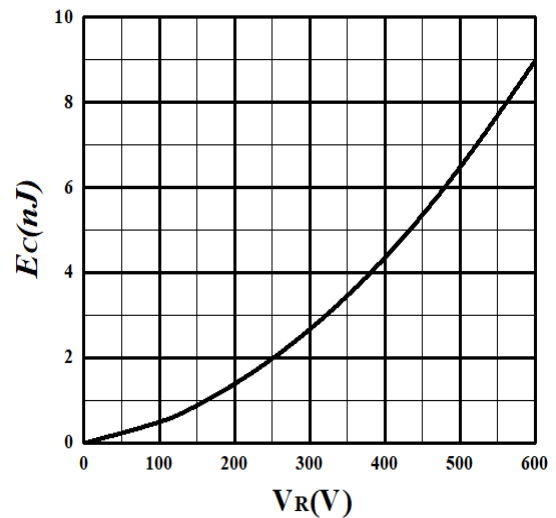

Figure 6. Capacitance Stored Energy

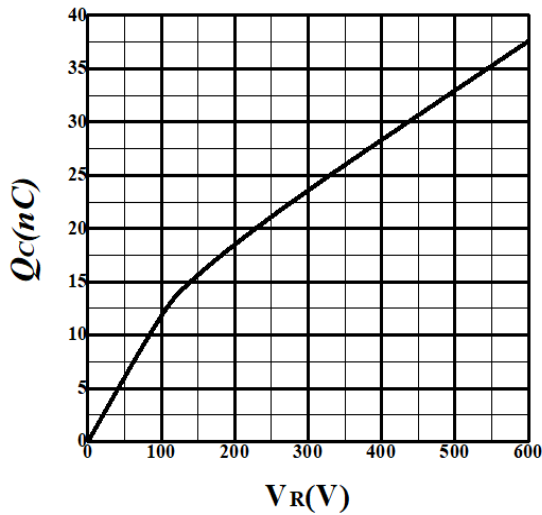
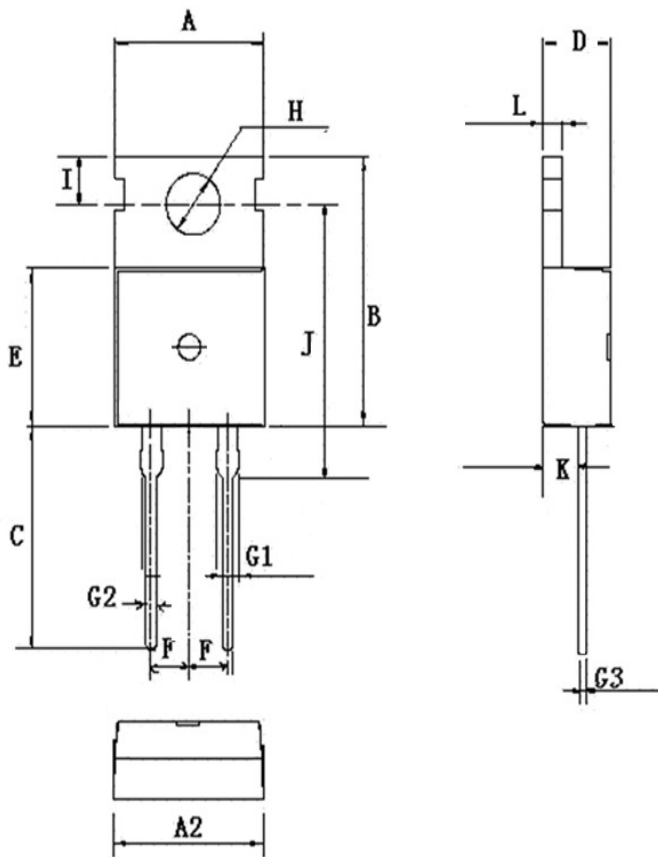

Figure 7. Total Capacitance Charge vs. Reverse Voltage

10. Package



SYMBOL	mm		
	MIN	NOM	MAX
A	9.66	9.90	10.28
A2	9.80	10.00	10.20
B	15.60	15.70	15.80
C	12.70	13.08	14.27
D	4.30	4.50	4.70
E	8.59	9.20	9.40
F	2.54 BSC		
G1	1.32	1.52	1.62
G2	0.70	0.80	0.95
G3	0.45	0.50	0.60
H dia.	3.50	3.60	3.70
I	2.70	2.80	2.90
J	15.70	15.90	16.25
K	2.20	2.40	2.90
L	1.15	1.30	1.40

11. Ordering information

Part Number	TSSiC065S020C
Package	TO-220-2L
Marking	TSSiC065S020C
Unit Quantity	600 EA
Packing Type	Tube
RoHS	Yes

12. Notes

SiC Schottky diode portfolio: <http://www.thrivesemi.com/>

Copyright © 2020 Thrivesemi Microelectronic Technology Co., Ltd. All Rights Reserved